





PROFILATI A FREDDO IN ACCIAIO-ALLUMINIO E LEGHE



Guida supporto in acciaio, con zincatura elettrolitica e passivazione  
 Steel mounting rail, galvanic zinc plating and passivation  
 Tragschiene aus Stahl, mit galvanische Verzinkung und Passivierung  
 Profilé asymétrique en acier, zingage galvanique avec passivation

Norme - Standards - Normen - Normes  
 EN 60715

Cod. - Part.No. - Artikel - Nr. N° Article					
	Giallo - Yellow Gelb - Jaune	Bianco - White Weiss/Blau - Blanc			
1 M	011011 001 00001	012011 001 00001	20 M	0,730 / M	
2 M	011021 001 00001	012021 001 00001	40 M	0,730 / M	
3 M	011031 001 00001	012031 001 00001	30 M	0,730 / M	

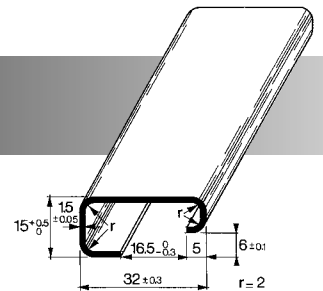
TS 32



Cod. - Part.No. - Artikel - Nr. N° Article					
	Giallo - Yellow Gelb - Jaune	Bianco - White Weiss/Blau - Blanc			
1 M	011011 001 02000	012011 001 02000	20 M	0,690 / M	
2 M	011021 001 02000	012021 001 02000	40 M	0,690 / M	
3 M	011031 001 02000	012031 001 02000	30 M	0,690 / M	

TS 32/F5A

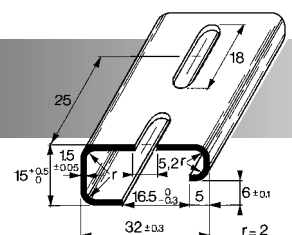





PROFILATI A FREDDO IN ACCIAIO-ALLUMINIO E LEGHE



Guida supporto in acciaio, con zincatura elettrolitica e passivazione  
Steel mounting rail, galvanic zinc plating and passivation  
Tragschiene aus Stahl, mit galvanische Verzinkung und Passivierung  
Profilé asymétrique en acier, zingage galvanique avec passivation

Norme - Standards - Normen - Normes  
EN 60715

Cod. - Part.No. - Artikel - Nr. N° Article				
	Giallo - Yellow Gelb - Jaune	Bianco - White Weiss/Blau - Blanc		
1 M	011011 001 03000	012011 001 03000	20 M	0,690 / M
2 M	011021 001 03000	012021 001 03000	40 M	0,690 / M
3 M	011031 001 03000	012031 001 03000	30 M	0,690 / M

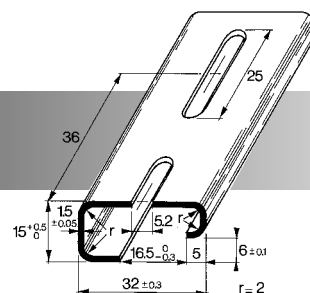
TS 32/F5



Cod. - Part.No. - Artikel - Nr. N° Article				
	Giallo - Yellow Gelb - Jaune	Bianco - White Weiss/Blau - Blanc		
1 M	011011 001 04000	012011 001 04000	20 M	0,690 / M
2 M	011021 001 04000	012021 001 04000	40 M	0,690 / M
3 M	011031 001 04000	012031 001 04000	30 M	0,690 / M

TS 32/F6

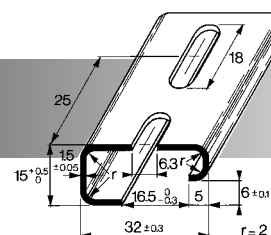





**PROFILATI A FREDDO IN ACCIAIO-ALLUMINIO E LEGHE**



Guida supporto in acciaio, con zincatura elettrolitica e passivazione  
 Steel mounting rail, galvanic zinc plating and passivation  
 Tragschiene aus Stahl, mit galvanische Verzinkung und Passivierung  
 Profilé asymétrique en acier, zingage galvanique avec passivation

Norme - Standards - Normen - Normes  
 EN 60715

Cod. - Part.No. - Artikel - Nr. N° Article				
	Giallo - Yellow Gelb - Jaune	Bianco - White Weiss/Blau - Blanc		
1 M	011011 002 00001	012011 002 00001	20 M	0,350 / M
2 M	011021 002 00001	012021 002 00001	40 M	0,350 / M
3 M	011031 002 00001	012031 002 00001	60 M	0,350 / M

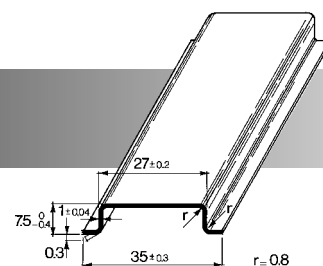
## TS 35



Cod. - Part.No. - Artikel - Nr. N° Article				
	Giallo - Yellow Gelb - Jaune	Bianco - White Weiss/Blau - Blanc		
1 M	011011 002 02000	012011 002 02000	20 M	0,300 / M
2 M	011021 002 02000	012021 002 02000	40 M	0,300 / M

## TS 35/F5A

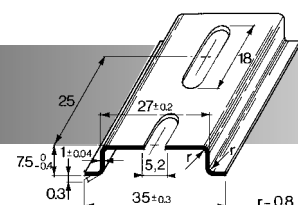





**PROFILATI A FREDDO IN ACCIAIO-ALLUMINIO E LEGHE**



Guida supporto in acciaio, con zincatura elettrolitica e passivazione  
 Steel mounting rail, galvanic zinc plating and passivation  
 Tragschiene aus Stahl, mit galvanische Verzinkung und Passivierung  
 Profilé asymétrique en acier, zingage galvanique avec passivation

Norme - Standards - Normen - Normes  
 EN 60715

Cod. - Part.No. - Artikel - Nr. N° Article				
	Giallo - Yellow Gelb - Jaune	Bianco - White Weiss/Blau - Blanc		
	1 M	011011 002 03000	012011 002 03000	20 M
2 M	011021 002 03000	012021 002 03000	40 M	0,300 / M

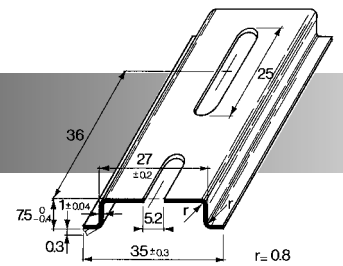
**TS 35/F5**



Cod. - Part.No. - Artikel - Nr. N° Article				
	Giallo - Yellow Gelb - Jaune	Bianco - White Weiss/Blau - Blanc		
	1 M	011011 002 04000	012011 002 04000	20 M
2 M	011021 002 04000	012021 002 04000	40 M	0,300 / M

**TS 35/F6**

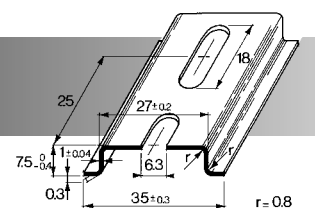



**PROFILATI A FREDDO IN ACCIAIO-ALLUMINIO E LEGHE**



Guida supporto in acciaio, con zincatura elettrolitica e passivazione  
 Steel mounting rail, galvanic zinc plating and passivation  
 Tragschiene aus Stahl, mit galvanische Verzinkung und Passivierung  
 Profilé asymétrique en acier, zingage galvanique avec passivation

Esecuzione con riferimento: Manufacture with reference:

Durchführung laut: Exécution avec référence:



Norme - Standards - Normen - Normes

EN 60715

Cod. - Part.No. - Artikel - Nr. N° Article				
	Giallo - Yellow Gelb - Jaune	Bianco - White Weiss/Blau - Blanc		
1 M	011011 003 00001	012011 003 00001	20 M	0,390 / M
2 M	011021 003 00001	012021 003 00001	40 M	0,390 / M
3 M	011031 003 00001	012031 003 00001	30 M	0,390 / M

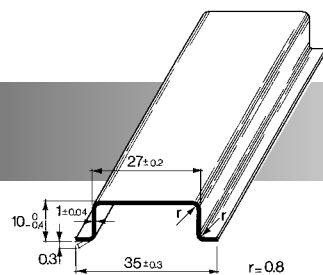
**TS 35/S**



Cod. - Part.No. - Artikel - Nr. N° Article				
	Giallo - Yellow Gelb - Jaune	Bianco - White Weiss/Blau - Blanc		
1 M	011011 003 02000	012011 003 02000	20 M	0,350 / M
2 M	011021 003 02000	012021 003 02000	40 M	0,350 / M

**TS 35/SF5A**

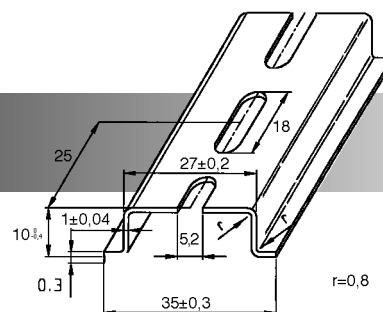



PROFILATI A FREDDO IN ACCIAIO-ALLUMINIO E LEGHE

Guida supporto in acciaio, con zincatura elettrolitica e passivazione  
Steel mounting rail, galvanic zinc plating and passivation  
Tragschiene aus Stahl, mit galvanische Verzinkung und Passivierung  
Profilé asymétrique en acier, zingage galvanique avec passivation

Esecuzione con riferimento: Manufacture with reference:

Durchführung laut: Exécution avec référence:



Norme - Standards - Normen - Normes

EN 60715

Cod. - Part.No. - Artikel - Nr. N° Article				
	Giallo - Yellow Gelb - Jaune	Bianco - White Weiss/Blau - Blanc		
1 M	011011 003 03000	012011 003 03000	20 M	0,350 / M
2 M	011021 003 03000	012021 003 03000	40 M	0,350 / M

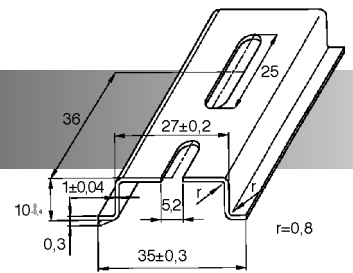
TS 35/SF5



Cod. - Part.No. - Artikel - Nr. N° Article				
	Giallo - Yellow Gelb - Jaune	Bianco - White Weiss/Blau - Blanc		
1 M	011011 003 04000	012011 003 04000	20 M	0,350 / M
2 M	011021 003 04000	012021 003 04000	40 M	0,350 / M

TS 35/SF6

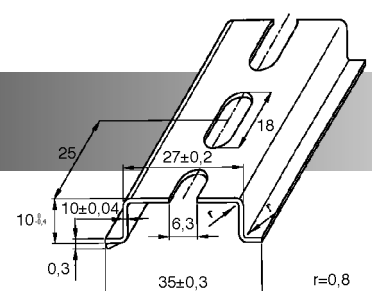



## PROFILATI A FREDDO IN ACCIAIO-ALLUMINIO E LEGHE

Guida supporto in acciaio, con zincatura elettrolitica e passivazione  
Steel mounting rail, galvanic zinc plating and passivation  
Tragschiene aus Stahl, mit galvanische Verzinkung und Passivierung  
Profilé asymétrique en acier, zingage galvanique avec passivation

Esecuzione con riferimento: Manufacture with reference:

Durchführung laut: Exécution avec référence:

Norme - Standards - Normen - Normes

EN 60715

Cod. - Part.No. - Artikel - Nr. N° Article				
	Giallo - Yellow Gelb - Jaune	Bianco - White Weiss/Blau - Blanc		
1 M	011011 004 00001	012011 004 00001	10 M	0,670 / M
2 M	011021 004 00001	012021 004 00001	20 M	0,670 / M
3 M	011031 004 00001	012031 004 00001	30 M	0,670 / M

## TS 35/C

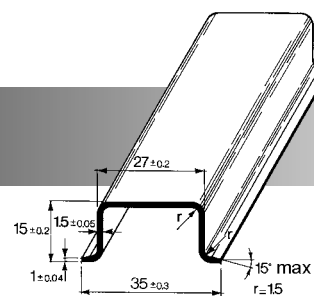

Cod. - Part.No. - Artikel - Nr. N° Article				
	Giallo - Yellow Gelb - Jaune	Bianco - White Weiss/Blau - Blanc		
1 M	011011 004 02000	012011 004 02000	10 M	0,615 / M
2 M	011021 004 02000	012021 004 02000	20 M	0,615 / M
3 M	011031 004 02000	012031 004 02000	30 M	0,615 / M

## TS 35/CF5A

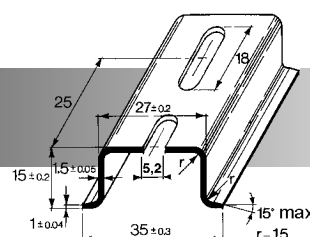



**PROFILATI A FREDDO IN ACCIAIO-ALLUMINIO E LEGHE**



Guida supporto in acciaio, con zincatura elettrolitica e passivazione  
 Steel mounting rail, galvanic zinc plating and passivation  
 Tragschiene aus Stahl, mit galvanische Verzinkung und Passivierung  
 Profilé asymétrique en acier, zingage galvanique avec passivation

Esecuzione con riferimento: Manufacture with reference:

Durchführung laut: Exécution avec référence:



Norme - Standards - Normen - Normes

EN 60715

Cod. - Part.No. - Artikel - Nr. N° Article				
	Giallo - Yellow Gelb - Jaune	Bianco - White Weiss/Blau - Blanc		
1 M	011011 004 03000	012011 004 03000	10 M	0,615 / M
2 M	011021 004 03000	012021 004 03000	20 M	0,615 / M
3 M	011031 004 03000	012031 004 03000	30 M	0,615 / M

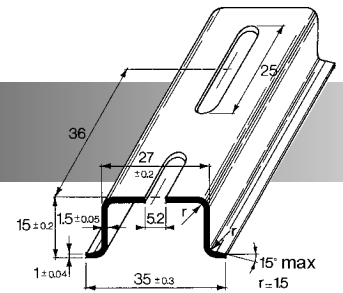
**TS 35/CF5**



Cod. - Part.No. - Artikel - Nr. N° Article				
	Giallo - Yellow Gelb - Jaune	Bianco - White Weiss/Blau - Blanc		
1 M	011011 004 04000	012011 004 04000	10 M	0,615 / M
2 M	011021 004 04000	012021 004 04000	20 M	0,615 / M
3 M	011031 004 04000	012031 004 04000	30 M	0,615 / M

**TS 35/CF6**

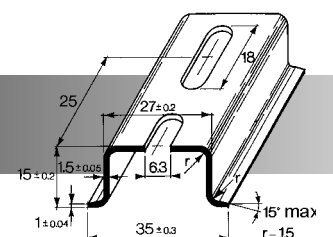





PROFILATI A FREDDO IN ACCIAIO-ALLUMINIO E LEGHE



Guida supporto in acciaio, con zincatura elettrolitica e passivazione  
Steel mounting rail, galvanic zinc plating and passivation  
Tragschiene aus Stahl, mit galvanische Verzinkung und Passivierung  
Profilé asymétrique en acier, zingage galvanique avec passivation

Norme - Standards - Normen - Normes  
EN 60715

Cod. - Part.No. - Artikel - Nr. N° Article				
	Giallo - Yellow Gelb - Jaune	Bianco - White Weiss/Blau - Blanc		
1 M	011011 007 00000	012011 007 00000	50 M	0,165 / M
2 M	011021 007 00000	012021 007 00000	100 M	0,165 / M

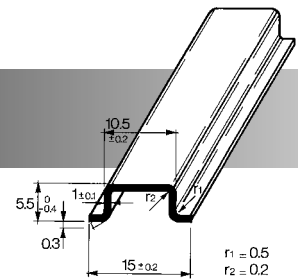
TS 15



Cod. - Part.No. - Artikel - Nr. N° Article				
	Giallo - Yellow Gelb - Jaune	Bianco - White Weiss/Blau - Blanc		
1 M	011011 007 01000	012011 007 01000	50 M	0,140/ M
2 M	011021 007 01000	012021 007 01000	100 M	0,140/ M

TS 15/F

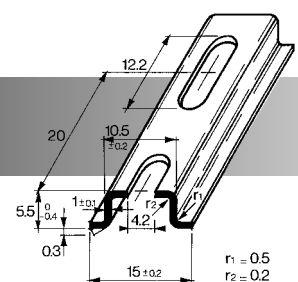





**PROFILATI A FREDDO IN ACCIAIO-ALLUMINIO E LEGHE**



Guida supporto in acciaio, con zincatura elettrolitica e passivazione  
 Steel mounting rail, galvanic zinc plating and passivation  
 Tragschiene aus Stahl, mit galvanische Verzinkung und Passivierung  
 Profilé asymétrique en acier, zingage galvanique avec passivation

Norme - Standards - Normen - Normes  
 EN 60715

Cod. - Part.No. - Artikel - Nr. N° Article				
	Giallo - Yellow Gelb - Jaune	Bianco - White Weiss/Blau - Blanc		
1 M	011011 005 00001	012011 005 00001	10 M	0,950 / M
2 M	011021 005 00001	012021 005 00001	20 M	0,950 / M
3 M	011031 005 00001	012031 005 00001	30 M	0,950 / M

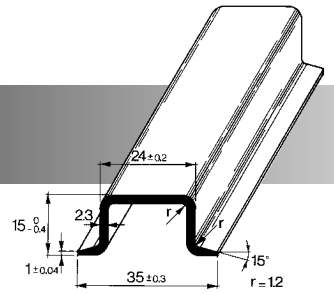
**TS 35/C1**



Cod. - Part.No. - Artikel - Nr. N° Article				
	Giallo - Yellow Gelb - Jaune	Bianco - White Weiss/Blau - Blanc		
2 M	011021 006 00000	012021 006 00000	8 M	2,650 / M

**TS 75**

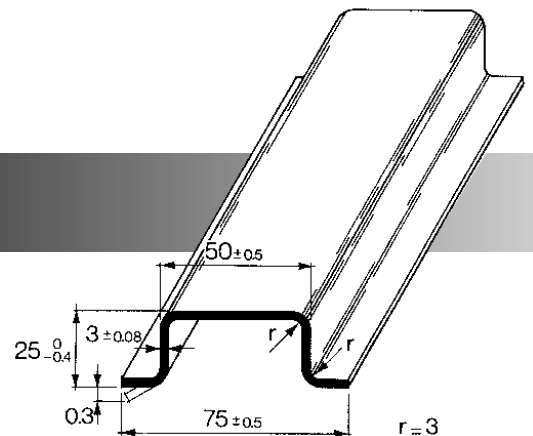





PROFILATI A FREDDO IN ACCIAIO-ALLUMINIO E LEGHE

Guida supporto in acciaio, zincato a caldo con processo Sendzimir  
Steel mounting rail, hot-dip galvanized using the Sendzimir process  
Tragschiene aus Stahl, sendzimir verzinkt (Bandverzinkt)  
Profilé asymétrique en acier, galvanisation à chaud selon le procédé Sendzimir

Norme - Standards - Normen - Normes  
EN 60715

	Cod. - Part.No. - Artikel - Nr. N° Article		
1 M	013011 001 00000	20 M	0,730 / M
2 M	013021 001 00000	40 M	0,730 / M
3 M	013031 001 00000	30 M	0,730 / M

TS 32/Sz.

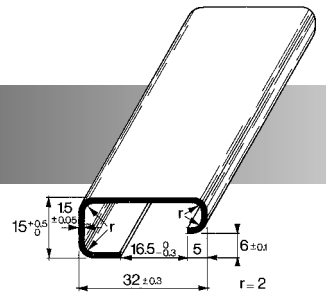

	Cod. - Part.No. - Artikel - Nr. N° Article		
1 M	013011 001 02000	20 M	0,690 / M
2 M	013021 001 02000	40 M	0,690 / M
3 M	013031 001 02000	30 M	0,690 / M

TS 32/F5A Sz.

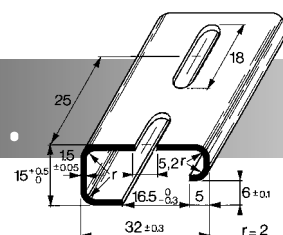



PROFILATI A FREDDO IN ACCIAIO-ALLUMINIO E LEGHE

Guida supporto in acciaio, zincato a caldo con processo Sendzimir  
Steel mounting rail, hot-dip galvanized using the Sendzimir process  
Tragschiene aus Stahl, sendzimir verzinkt (Bandverzinkt)  
Profilé asymétrique en acier, galvanisation à chaud selon le procédé Sendzimir

Norme - Standards - Normen - Normes  
EN 60715

	Cod. - Part.No. - Artikel - Nr. N° Article		
1 M	013011 001 03000	20 M	0,690 / M
2 M	013021 001 03000	40 M	0,690 / M
3 M	013031 001 03000	30 M	0,690 / M

TS 32/F5 Sz.

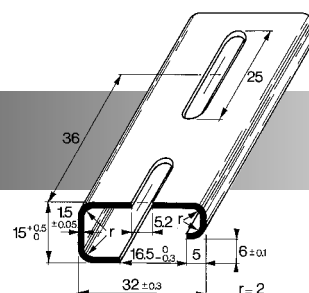

	Cod. - Part.No. - Artikel - Nr. N° Article		
1 M	013011 001 04000	20 M	0,690 / M
2 M	013021 001 04000	40 M	0,690 / M
3 M	013031 001 04000	30 M	0,690 / M

TS 32/F6 Sz.

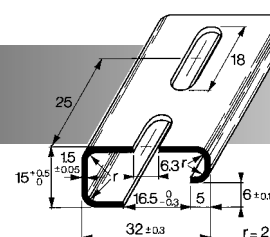





## PROFILATI A FREDDO IN ACCIAIO-ALLUMINIO E LEGHE



Guida supporto in acciaio, zincato a caldo con processo Sendzimir  
Steel mounting rail, hot-dip galvanized using the Sendzimir process  
Tragschiene aus Stahl, sendzimir verzinkt (Bandverzinkt)  
Profilé asymétrique en acier, galvanisation à chaud selon le procédé Sendzimir

Norme - Standards - Normen - Normes  
EN 60715

	Cod. - Part.No. - Artikel - Nr. N° Article		
1 M	013011 002 00000	20 M	0,350 / M
2 M	013021 002 00000	40 M	0,350 / M
3 M	013031 002 00000	36 M	0,350 / M

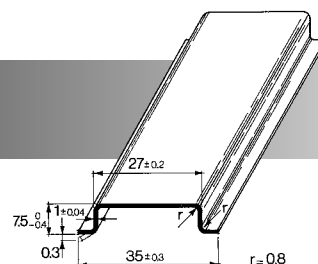
## TS 35/Sz.



	Cod. - Part.No. - Artikel - Nr. N° Article		
1 M	013011 002 02000	20 M	0,300 / M
2 M	013021 002 02000	40 M	0,300 / M

## TS 35/F5A Sz.

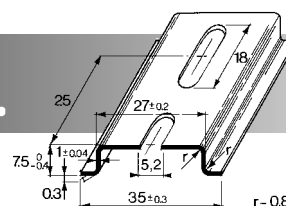





PROFILATI A FREDDO IN ACCIAIO-ALLUMINIO E LEGHE

Guida supporto in acciaio, zincato a caldo con processo Sendzimir  
Steel mounting rail, hot-dip galvanized using the Sendzimir process  
Tragschiene aus Stahl, sendzimir verzinkt (Bandverzinkt)  
Profilé asymétrique en acier, galvanisation à chaud selon le procédé Sendzimir

Norme - Standards - Normen - Normes  
EN 60715

	Cod. - Part.No. - Artikel - Nr. N° Article		
1 M	013011 002 03000	20 M	0,300 / M
2 M	013021 002 03000	40 M	0,300 / M

TS 35/F5 Sz

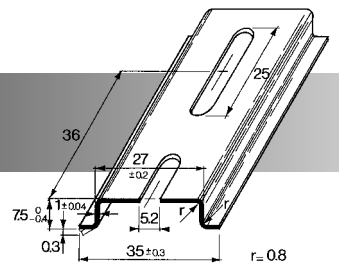

	Cod. - Part.No. - Artikel - Nr. N° Article		
1 M	013011 002 04000	20 M	0,300 / M
2 M	013021 002 04000	40 M	0,300 / M

TS 35/F6 Sz

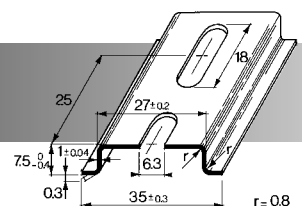



## PROFILATI A FREDDO IN ACCIAIO-ALLUMINIO E LEGHE

Guida supporto in acciaio, zincato a caldo con processo Sendzimir

Steel mounting rail, hot-dip galvanized using the Sendzimir process

Tragschiene aus Stahl, sendzimir verzinkt (Bandverzinkt)



Profilé asymétrique en acier, galvanisation à chaud selon le procédé Sendzimir

Esecuzione con riferimento: Manufacture with reference:

Durchführung laut: Exécution avec référence:

Norme - Standards - Normen - Normes

EN 60715

	Cod. - Part.No. - Artikel - Nr. N° Article		
1 M	013011 004 00000	10 M	0,670 / M
2 M	013021 004 00000	20 M	0,670 / M
3 M	013031 004 00000	30 M	0,670 / M

## TS 35/C Sz.

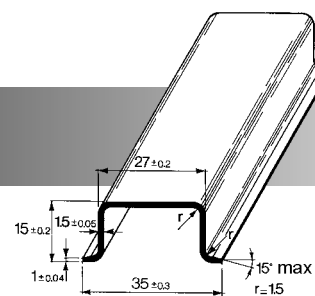

	Cod. - Part.No. - Artikel - Nr. N° Article		
1 M	013011 004 02000	10 M	0,615 / M
2 M	013021 004 02000	20 M	0,615 / M
3 M	013031 004 02000	30 M	0,615 / M

## TS 35/CF5A Sz.

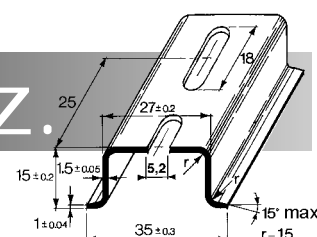



PROFILATI A FREDDO IN ACCIAIO-ALLUMINIO E LEGHE

Guida supporto in acciaio, zincato a caldo con processo Sendzimir

Steel mounting rail, hot-dip galvanized using the Sendzimir process

Tragschiene aus Stahl, sendzimir verzinkt (Bandverzinkt)

Profilé asymétrique en acier, galvanisation à chaud selon le procédé Sendzimir

Esecuzione con riferimento: Manufacture with reference:

Durchführung laut: Exécution avec référence:

Norme - Standards - Normen - Normes

EN 60715

	Cod. - Part.No. - Artikel - Nr. N° Article		
1 M	013011 004 03000	10 M	0,615 / M
2 M	013021 004 03000	20 M	0,615 / M
3 M	013031 004 03000	30 M	0,615 / M

TS 35/CF5 Sz.

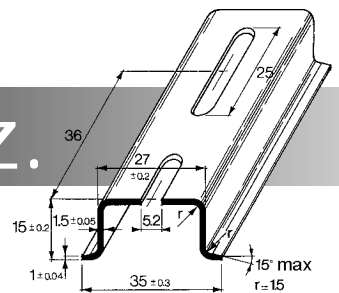

	Cod. - Part.No. - Artikel - Nr. N° Article		
1 M	013011 004 04000	10 M	0,615 / M
2 M	013021 004 04000	20 M	0,615 / M
3 M	013031 004 04000	30 M	0,615 / M

TS 35/CF6 Sz.

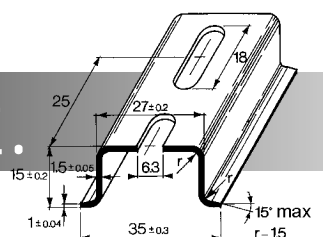



PROFILATI A FREDDO IN ACCIAIO-ALLUMINIO E LEGHE

Guida supporto in alluminio  
Aluminium mounting rail  
Tragschiene aus Aluminium  
Profilé en aluminium

Norme - Standards - Normen - Normes  
EN 60715

	Cod. - Part.No. - Artikel - Nr. N° Article		
2 M	015021 001 00000	40 M	0,240 / M

## TS 32 ALU

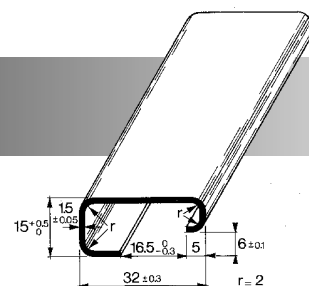

	Cod. - Part.No. - Artikel - Nr. N° Article		
2 M	015021 002 00000	40 M	0,122 / M

## TS 35 ALU

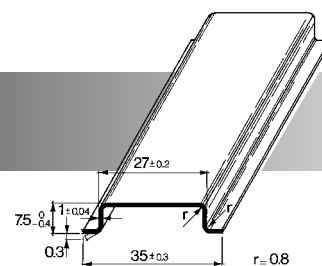

Esecuzione con riferimento: Manufacture with reference:  
Durchführung laut: Exécution avec référence:  
Norme - Standards - Normen - Normes  
EN 60715

	Cod. - Part.No. - Artikel - Nr. N° Article		
2 M	015021 004 00000	20 M	0,343 / M

## TS 35/C ALU

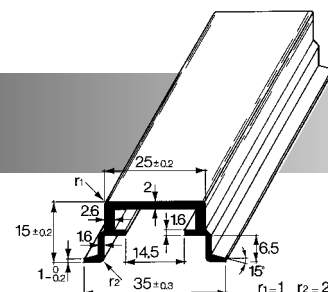



PROFILATI A FREDDO IN ACCIAIO-ALLUMINIO E LEGHE

Guida supporto in RAME  
COPPER Mounting rail  
Tragschiene aus KUPFER  
Profilés en CUIVRE

Norme - Standards - Normen - Normes  
EN 60715

	Cod. - Part.No. - Artikel - Nr. N° Article		
2 M	017021 002 0000	40 M	0,400 / M

## TS 35 Cu

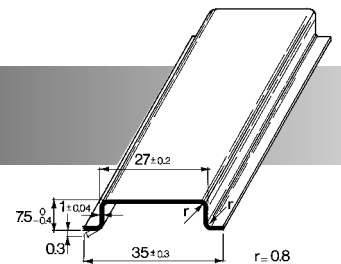



Esecuzione con riferimento: Manufacture with reference:  
Durchführung laut: Exécution avec référence:  
Norme - Standards - Normen - Normes  
EN 60715

	Cod. - Part.No. - Artikel - Nr. N° Article		
2 M	017021 004 0000	20 M	0,770 / M

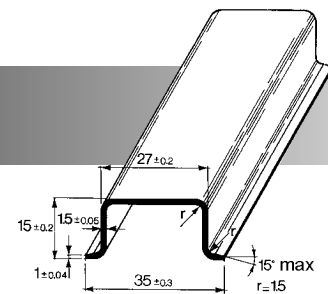
## TS 35/C Cu



Norme - Standards - Normen - Normes  
EN 60715

	Cod. - Part.No. - Artikel - Nr. N° Article		
2 M	017021 005 0000	20 M	1,085 / M

## TS 35/C1 Cu

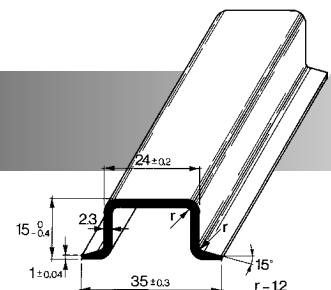

Guida supporto in acciaio, zincato a caldo con processo Sendzimir  
Steel mounting rail, hot-dip galvanized using the Sendzimir process

Tragschiene aus Stahl, sendzimir verzinkt (Bandverzinkt)

Profilé asymétrique en acier, galvanisation à chaud selon le procédé Sendzimir

Esecuzione con riferimento: Manufacture with reference:

Durchführung laut: Exécution avec référence:

Norme - Standards - Normen - Normes

EN 60715

	Cod. - Part.No. - Artikel - Nr. N° Article		
1 M	013011 004 03000	10 M	0,615 / M
2 M	013021 004 03000	20 M	0,615 / M
3 M	013031 004 03000	30 M	0,615 / M

## TS 35/CF5 Sz.

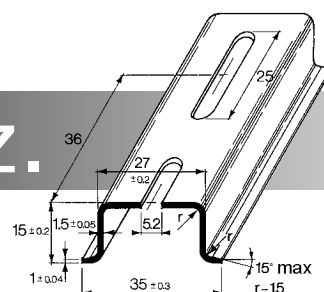

	Cod. - Part.No. - Artikel - Nr. N° Article		
1 M	013011 004 04000	10 M	0,615 / M
2 M	013021 004 04000	20 M	0,615 / M
3 M	013031 004 04000	30 M	0,615 / M

## TS 35/CF6 Sz.

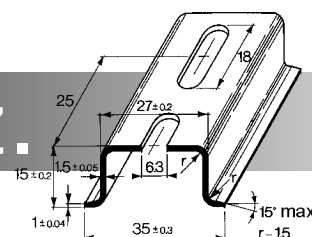

**KLINKMANN**

www.klinkmann.com

**Helsinki**

tel. +358 9 540 4940  
automation@klinkmann.fi

**St. Petersburg**

tel. +7 812 327 3752  
klinkmann@klinkmann.spb.ru

**Moscow**

tel. +7 495 641 1616  
moscow@klinkmann.spb.ru

**Yekaterinburg**

tel. +7 343 376 5393  
yekaterinburg@klinkmann.spb.ru

**Mineralnye Vody**

tel. +7 879 226 1934  
pyatigorsk@klinkmann.spb.ru

**Samara**

tel. +7 846 342 6655  
samara@klinkmann.spb.ru

**Kiev**

tel. +38 044 495 3340  
klinkmann@klinkmann.kiev.ua

**Riga**

tel. +371 6738 1617  
klinkmann@klinkmann.lv

**Vilnius**

tel. +370 5 215 1646  
post@klinkmann.lt

**Tallinn**

tel. +372 668 4500  
klinkmann.est@klinkmann.ee

**Minsk**

tel. +375 17 200 0876  
minsk@klinkmann.com